



100V N-Channel MOSFETS

SOT-23-3 Pin Configuration

LDN0988

BVDSS	RDSON	ID
100V	41mΩ	3.5A

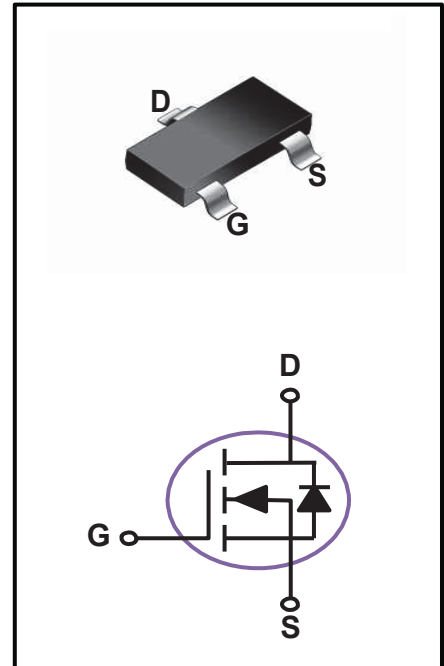

Feature

- 100V, 3.5A, $R_{DS(ON)} = 41m\Omega @ V_{GS} = 10V$
- Improved dv/dt capability
- Fast switching
- Green Device Available

Applications

- Notebook
- Load Switch
- LED applications
- Hand-held Instruments

MAXIMUM RATINGS AND CHARACTERISTICS

@ 25°C Ambient Temperature (unless otherwise noted)

Parameter	Symbol	Rating	Units
Drain-Source Voltage	V_{DS}	100	V
Gate-Source Voltage	V_{GS}	+20 / -12	V
Drain Current – Continuous ($T_A=25^\circ C$)	I_D	3.5	A
Drain Current – Continuous ($T_A=70^\circ C$)		2.7	A
Drain Current – Pulsed ¹	I_{DM}	14	A
Power Dissipation ($T_A=25^\circ C$)	P_D	1.56	W
Power Dissipation – Derate above 25°C		12.5	mW/°C
Storage Temperature Range °C	T_{STG}	-55 to 150	°C
Operating Junction Temperature Range °C	T_J	-55 to 150	°C

Thermal Characteristics

Parameter	Symbol	Typ.	Max.	Unit
Thermal Resistance Junction to ambient	$R_{\theta JA}$	---	80	°C/W

MOSFET ELECTRICAL CHARACTERISTICS $T_A=25^{\circ}\text{C}$ unless otherwise specified

Parameter	Symbol	Conditions	Min.	Typ.	Max.	Unit
Drain-Source Breakdown Voltage	BV_{DSS}	$V_{GS}=0V, I_D=-250\mu A$	100	---	---	V
Drain-Source Leakage Current	I_{DSS}	$V_{DS}=100V, V_{GS}=0V, T_J=25^{\circ}\text{C}$	---	---	1	μA
		$V_{DS}=80V, V_{GS}=0V, T_J=100^{\circ}\text{C}$	---	---	10	μA
Gate-Source Leakage Current	I_{GSS}	$V_{GS} 20V, V_{DS}=0V$	---	---	100	nA

Static Drain-Source On-Resistance	$R_{DS(ON)}$	$V_{GS}=10V, I_D=3A$	---	34	41	m Ω
		$V_{GS}=4.5V, I_D=2A$	---	46	60	m Ω
Gate Threshold Voltage	$V_{GS(th)}$	$V_{GS}=V_{DS}, I_D=250\mu A$	1	1.5	2.5	V
Forward Transconductance	g_{fs}	$V_{DS}=10V, I_D=1A$	---	3.8	---	S

Total Gate Charge ^{2,3}	Q_g	$V_{DS}=30V, V_{GS}=10V, I_D=3A$	---	7.7	11	nC
Gate-Source Charge ^{2,3}	Q_{gs}		---	1.1	1.6	
Gate-Drain Charge ^{2,3}	Q_{gd}		---	3	4.5	
Turn-On Delay Time ^{2,3}	$T_{d(on)}$	$V_{DD}=50V, V_{GS}=10V, R_G=3.3\Omega$ $I_D=1A$	---	7.4	15	ns
Rise Time ^{2,3}	T_r		---	12	24	
Turn-Off Delay Time ^{2,3}	$T_{d(off)}$		---	23	46	
Fall Time ^{2,3}	T_f		---	16	32	
Input Capacitance	C_{iss}	$V_{DS}=50V, V_{GS}=0V, F=1\text{MHz}$	---	582	3000	pF
Output Capacitance	C_{oss}		---	188	280	
Reverse Transfer Capacitance	C_{rss}		---	12	240	
Gate resistance	R_g		$V_{GS}=0V, V_{DS}=0V, F=1\text{MHz}$	---	0.9	

Parameter	Symbol	Conditions	Min.	Typ.	Max.	Unit
Continuous Source Current	I_S	$V_G=V_D=0V, \text{Force Current}$	---	---	3.5	A
Pulsed Source Current	I_{SM}		---	---	7	A
Diode Forward Voltage	V_{SD}	$V_{GS}=0V, I_S=1A, T_J=25^{\circ}\text{C}$	---	---	1	V
Reverse Recovery Time ³	T_{rr}	$V_{GS}=0V, V_{DS}=0V, F=1\text{MHz}$	---	28	---	ns
Reverse Recovery Charge ³	Q_{rr}		---	23	---	nC

Note :

1. Repetitive Rating : Pulsed width limited by maximum junction temperature.
2. The data tested by pulsed , pulse width 300us , duty cycle 2%.
3. Essentially independent of operating temperature.

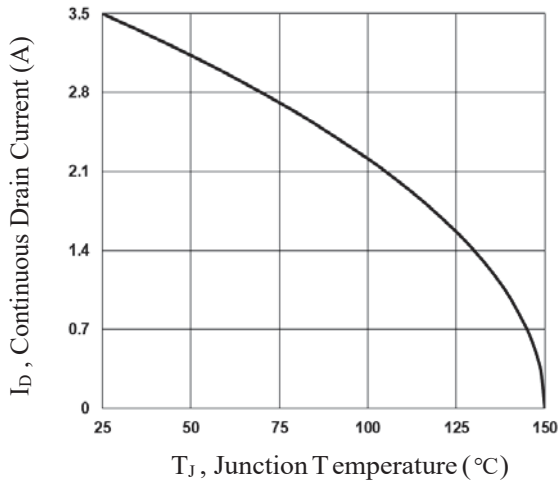

Fig.1 Continuous Drain Current vs. T_J

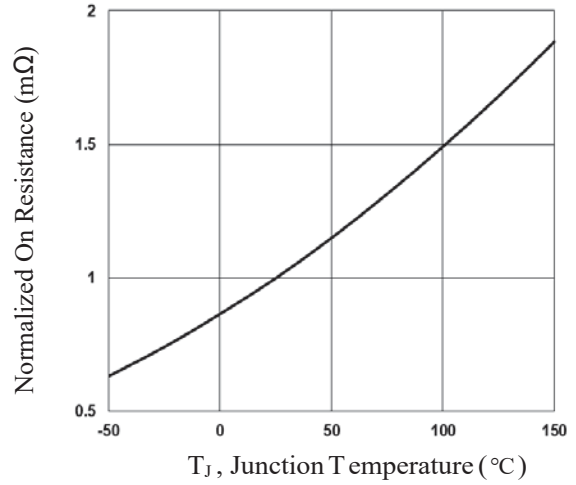

Fig.2 Normalized $R_{DS(on)}$ vs. T_J

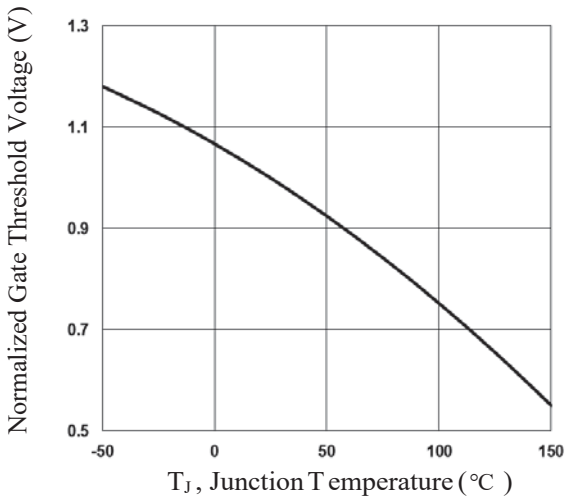

Fig.3 Normalized V_{th} vs. T_J

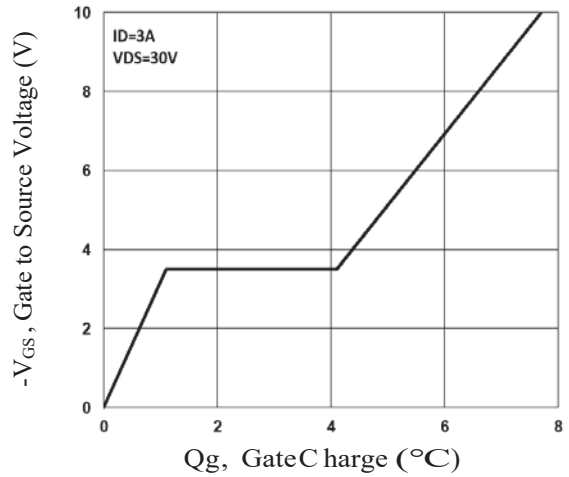

Fig.4 Gate Charge Waveform

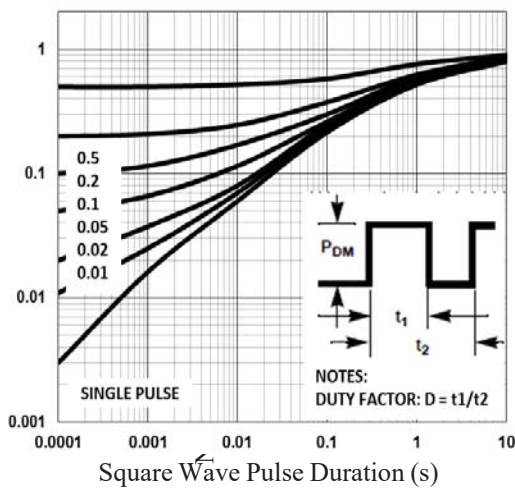

Fig.5 Normalized Transient Impedance

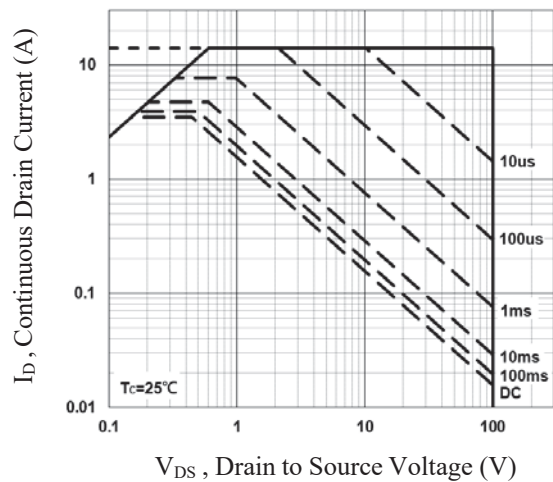

Fig.6 Maximum Safe Operation Area

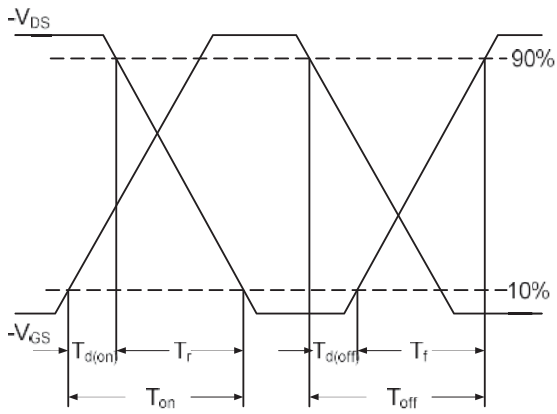

Fig.7 Switching Time Waveform

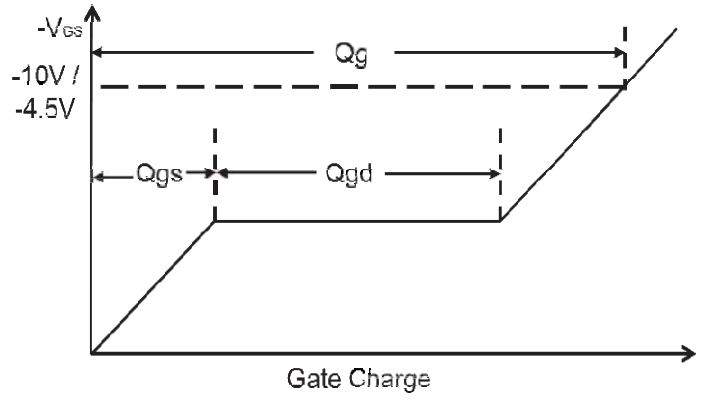
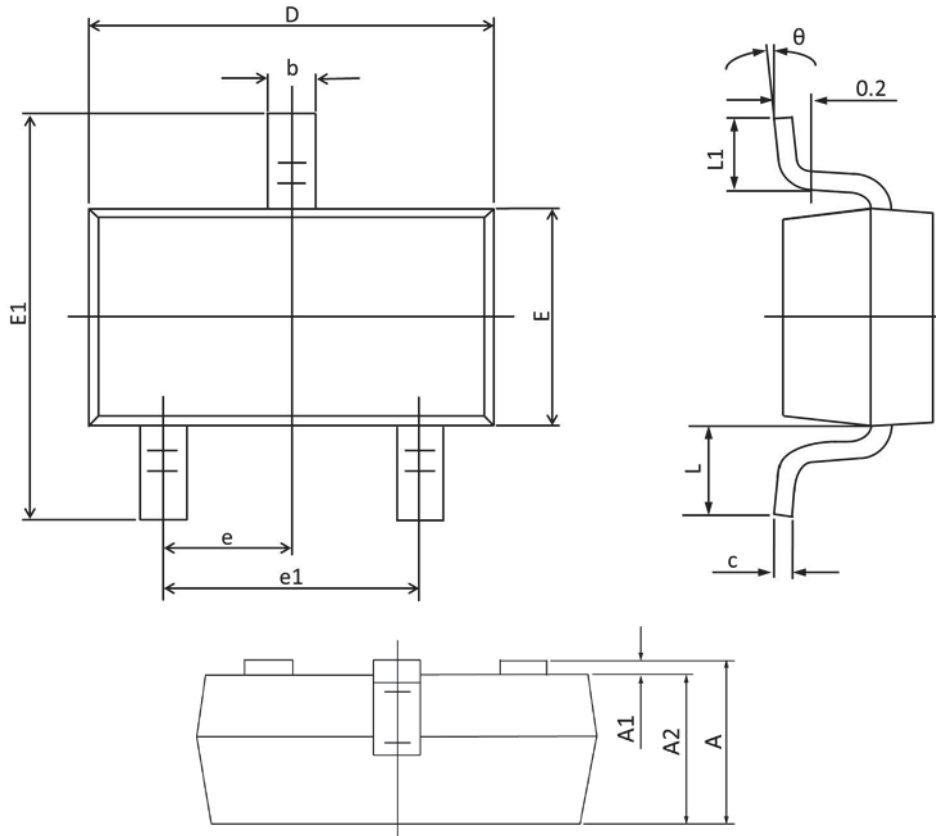

Fig.8 Gate Charge Waveform

SOT23-3 PACKAGE INFORMATION



Symbol	Dimensions In Millimeters		Dimensions In Inches	
	Min	Max	Min	Max
A	1.050	1.450	0.041	0.057
A1	0.000	0.150	0.000	0.006
A2	0.900	1.300	0.035	0.051
b	0.300	0.400	0.012	0.016
c	0.100	0.200	0.004	0.008
D	2.820	3.050	0.111	0.119
E	1.500	1.750	0.059	0.068
E1	2.600	3.000	0.101	0.117
e	0.950 TYP.		0.037 TYP.	
e1	1.800	2.000	0.071	0.079
L	0.700 REF.		0.028 REF.	
L1	0.300	0.600	0.012	0.024
Θ	0°	8°	0°	8°