

Three-terminal positive voltage regulator

FEATURES

- Maximum output current I_{OM}: 0.1A
- Output voltage V_O: 6V
- Continuous total dissipation
 $P_D: 0.625\text{ W}$ $T_A=25^\circ\text{C}$

MECHANICAL DATA

- Case: TO-92 Small Outline Plastic Package
- Polarity: Color band denotes cathode end
- Mounting Position: Any

TO-92

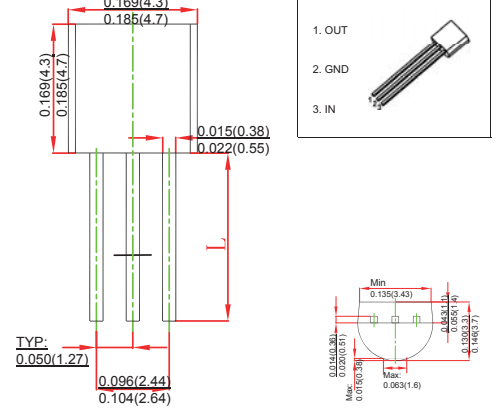

MAXIMUM RATINGS AND CHARACTERISTICS

@ 25°C Ambient Temperature (unless otherwise noted)

Parameter	Symbol	Value	Unit
Input Voltage	V _i	30	V
Thermal Resistance from Junction to Ambient	R _{θJA}	160	°C/W
Operating Junction Temperature Range	T _{OPR}	-25~+125	°C
Storage Temperature Range	T _{STG}	-65~+150	°C

ELECTRICAL CHARACTERISTICS AT SPECIFIED VIRTUAL JUNCTION TEMPERATURE

(V_i=10V, I_o=40mA, C_i=0.33μF, C_o=0.1μF, unless otherwise specified)

Parameter	Symbol	Test conditions	Min	Typ	Max	Unit	
Output voltage	V _o	25°C	5.75	6.0	6.25	V	
		0~125°C	8V ≤ V _i ≤ 20V, I _o = 1mA-40mA	5.7	6.0	6.3	V
			I _o = 1mA-70mA	5.7	6.0	6.3	V
Load Regulation	ΔV _o	I _o = 1mA-100mA, 25°C		16	80	mV	
		I _o = 1mA-40mA, 25°C		9	40	mV	
Line regulation	ΔV _o	8V ≤ V _i ≤ 20V, 25°C		35	175	mV	
		9V ≤ V _i ≤ 20V, 25°C		29	125	mV	
Quiescent Current	I _q	25°C		3.9	6.0	mA	
Quiescent Current Change	ΔI _q	9V ≤ V _i ≤ 20V, 0~125°C			1.5	mA	
		1mA ≤ I _o ≤ 40mA, 0~125°C			0.1	mA	
Output Noise Voltage	V _N	10Hz ≤ f ≤ 100KHz, 25°C		46		8V/V _o	
Ripple Rejection	RR	9V ≤ V _i ≤ 19V, f = 120Hz, 0~125°C	40	4		dB	
Dropout Voltage	V _d	25°C		1.7		V	

* Pulse test.

TYPICAL APPLICATION

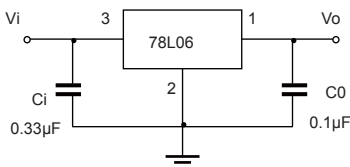

Typical Characteristics

Output Characteristics

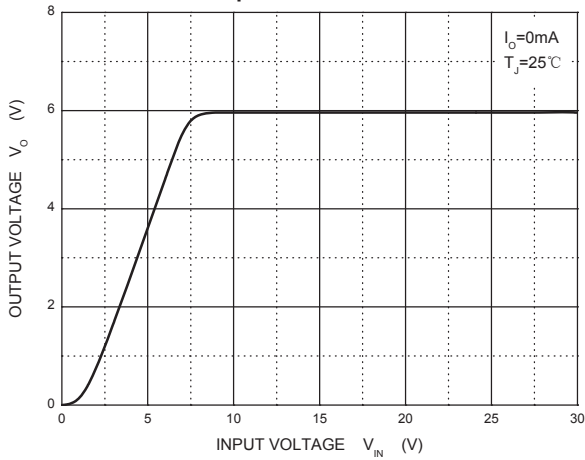

Dropout Characteristics

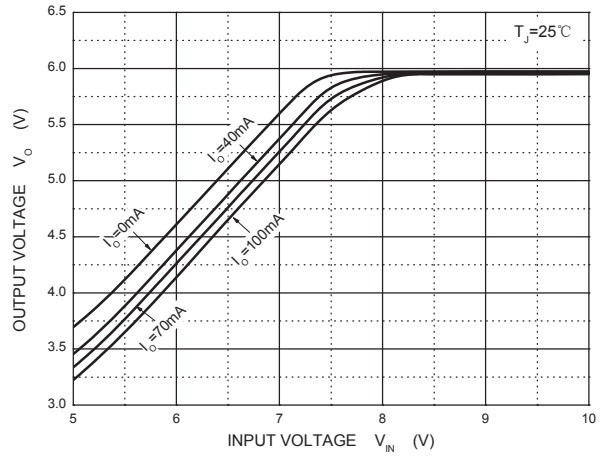

Quiescent Current

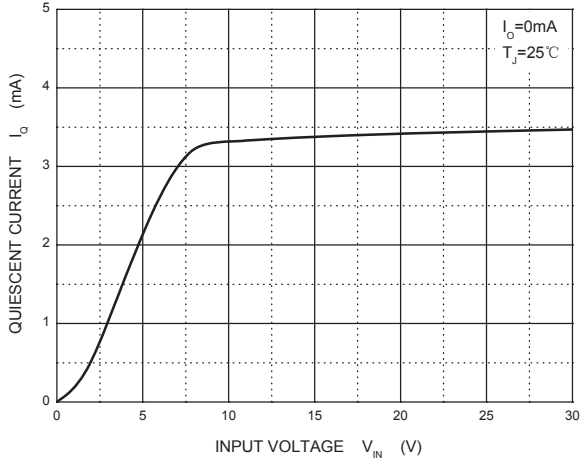

Current Cut-off Grid Voltage

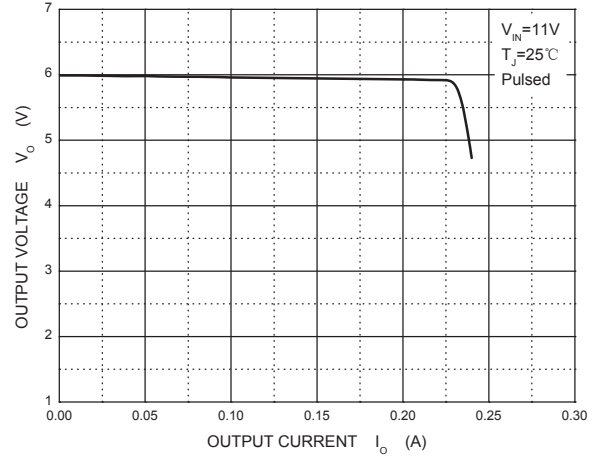

Output Voltage vs Junction Temperature

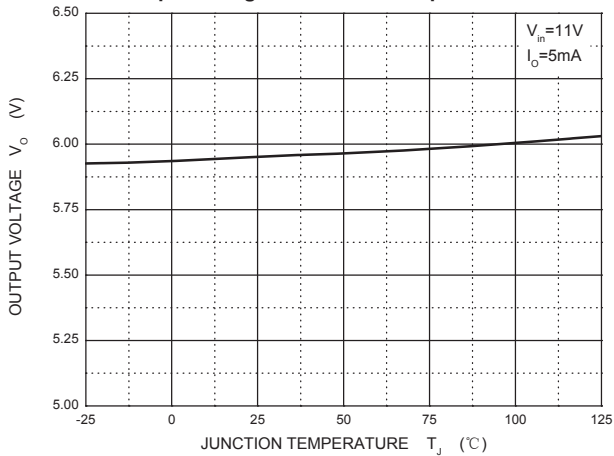

Power Derating Curve

